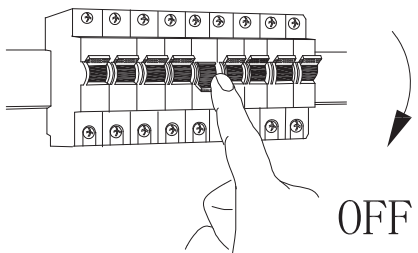

**A**

OFF

**GLOBO**

LIGHTING

[www.globo-lighting.com](http://www.globo-lighting.com)

67192-42

67192-42B

**B**

Installation

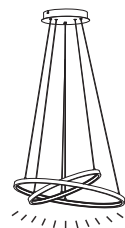
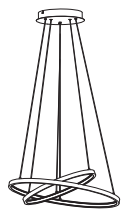

new dimming



T &lt; 3s

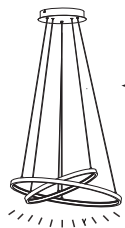

dimming level

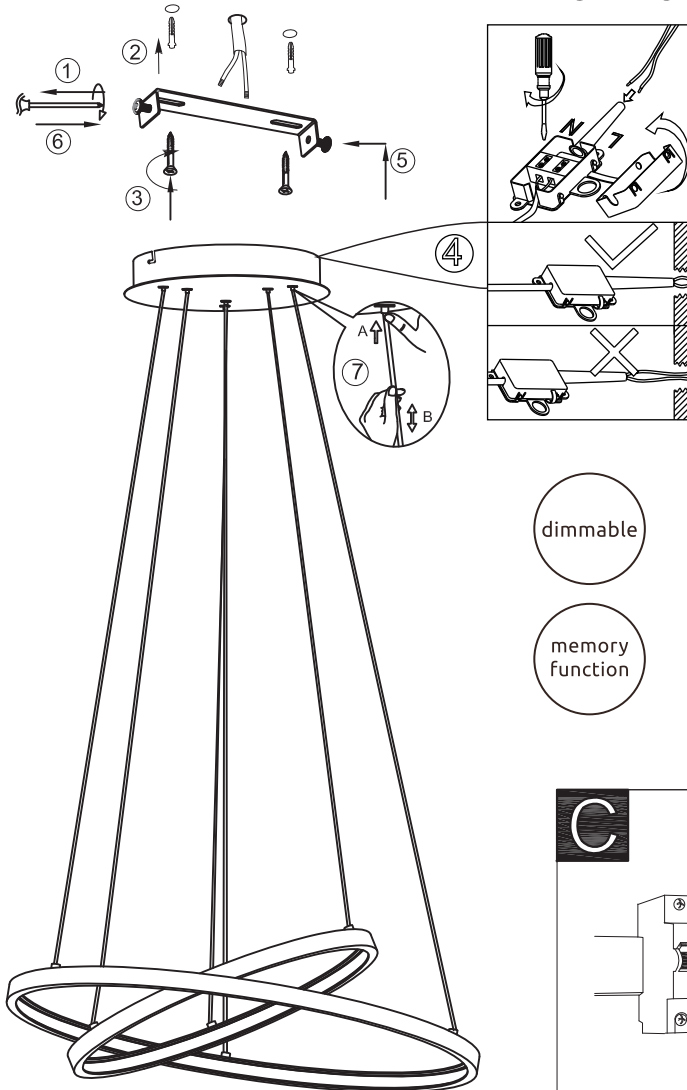
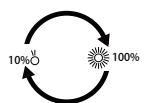

dimmable

memory function

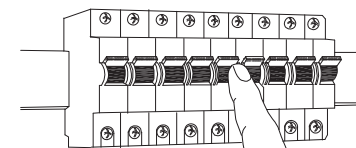
**C**

ON

GLOBO Handels GmbH  
 Gewerbestrasse 3  
 A-9184 Sankt Peter AUSTRIA

## Lichtquelle:

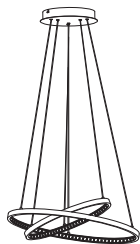

### **DEU:**

#### Lichtquelle:

Die Lichtquelle ist nicht tauschbar, weil sie konstruktionsbedingt fest mit dem umgebenden Produkt verbunden ist.

Dieses Produkt enthält eine Lichtquelle der Energieeffizienzklasse <E>.

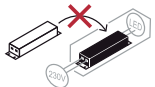

Betriebsgerät nicht austauschbar.



Leuchtmittel nicht austauschbar.

### **GBR:**

#### Light source:

The light source is not interchangeable because it is determined by the surrounding product design. This product contains a light source of energy efficiency class <E>.

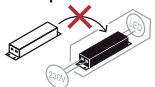

Non replaceable control gear.



Non replaceable light source.

### **BIH:**

#### Izvor svjetla :

Izvor svjetla nije zamjenjiv , jer je konstrukcijski pričvršćen na proizvod .  
Ovaj proizvod sadržava izvor svjetlosti klase energetske učinkovitosti <E>.

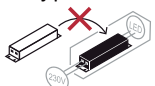

Pogonski uređaj se ne može zamjeniti



LED žarulje nije moguće zamjeniti

### **BG:**

#### Източник на светлина:

Източникът на светлина не може да се подменя, тъй като поради конструкцията си е трайно фиксиран към заобикалящия го продукт.

Този продукт включва светлинен източник с клас на енергийна ефективност <E>.

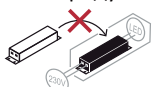

Управляващото устройство не може да се подменя.



Източникът на светлина не може да се подменя.

### **CZ:**

#### Zdroj světla:

Světelný zdroj není možné vyměnit, protože je díky své konstrukci pevně spojený s produktem.

Tento výrobek obsahuje světelný zdroj s třídou energetické účinnosti <E>.

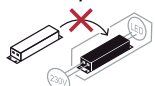

Předřadník není vyměnitelný.



Světelný zdroj není vyměnitelný.

### **DK:**

#### Lyskilde:

Lyskilden kan ikke udskiftes, fordi den er fast forbundet med det omgivende produkt. Dette produkt indeholder en lyskilde i energieffektivitetsklasse < E >.

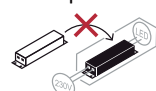

Enheden kan ikke udskiftes.



Lyskilden kan ikke udskiftes.

### **ET:**

#### Valgusallikas:

Valgusallikas ei ole välja vahetatav, sest ta on tootega ehituslikult kindlalt seotud.

Toode sisaldab energiatõhususe klassi <E> valgusallikat.

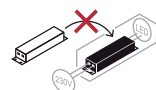

Juhtimisseadis ei ole välja vahetatav.



Lamp ei ole välja vahetatav.

### **FI:**

#### Valonlähde:

Valonlähdettä ei voi vaihtaa uuteen, sillä se on rakenteellisesti yhdistetty ympäröivään tuotteeseen.

Tämä tuote sisältää valonlähteen, jonka energiatehokkuusluokka on <E>.

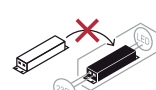

Liitäntälaitetta ei voi vaihtaa.



Valonlähdettä ei voi vaihtaa.

### **FR:**

#### Source lumineuse:

La source lumineuse n'est pas remplaçable car elle est, de par la construction du produit, liée de façon permanente à celui-ci.

Ce produit contient une source lumineuse de classe d'efficacité énergétique <E>.

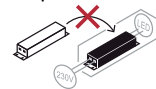

Dispositif de commande non remplaçable.

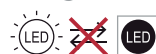

Ampoule non remplaçable.

### **GR:**

#### Φωτεινή πηγή:

Η φωτεινή πηγή δεν μπορεί να αντικατασταθεί, επειδή είναι για κατασκευαστικούς λόγους σταθερά συνδεδεμένη με το προϊόν που την περιβάλλει.

Το προϊόν αυτό περιέχει φωτεινή πηγή της τάξης ενεργειακής απόδοσης <E>.

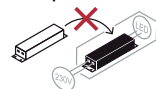

Η διάταξη λειτουργίας δεν μπορεί να αντικατασταθεί.



Ο λαμπτήρας δεν μπορεί να αντικατασταθεί.

**HU:****Fényforrás:**

A fényforrás nem cserélhető, mert felépítése miatt szilárdan csatlakozik a termékhez. Ez a termék egy <E> energiahatékonysági osztályú fényforrást tartalmaz.



Az előtét nem cserélhető.



A fényforrás nem cserélhető

**Isländisch/IS:****Ljósgrafi:**

Ljósgrafi er ekki útskiptanlegur vegna þess að hann er háður umliggjandi hönnun vörunnar.

Varan inniheldur ljósgrafa í orkuflokki <E>.

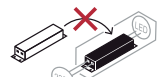

Ekki útskiptanlegur stýribúnaður.

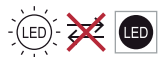

Ekki útskiptanlegur ljósgrafi.

**IT:****Sorgente luminosa:**

La sorgente luminosa non è intercambiabile perché è saldamente collegata al prodotto per via del suo design.

Questo prodotto contiene una sorgente luminosa di classe di efficienza energetica <E>.

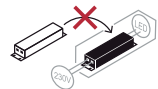

Alimentatore non sostituibile.



Lampadine non intercambiabili.

**HR:****Izvor svjetla:**

Izvor svjetla nije zamjenjiv, jer je konstrukcijski pričvršćen na proizvod.

Ovaj proizvod sadržava izvor svjetlosti klase energetske učinkovitosti <E>.

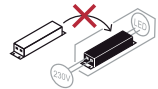

Pogonski uređaj se ne može zamjeniti



LED žarulje nije moguće zamjeniti

**LV:****Gaismas avots:**

Gaismas avotu nevar nomainīt, jo tas konstrukcijā ir cieši savienots ar izstrādājuma apkārtējo daļu.

Šis ražojums satur gaismas avotu, kura energoefektivitātes klase ir <E>.

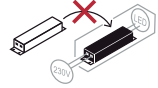

Vadības ierīci nevar nomainīt.

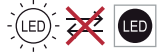

Apgaismes līdzekli nevar nomainīt.

**LT:****Šviesos šaltinis:**

Šis šviesos šaltinis yra nekeičiamas, nes jis prijungtas prie gaminio pagal jo konstrukciją.

Šiame gaminyje yra šviesos šaltinis, kurio energijos vartojimo efektyvumo klasė <E>.

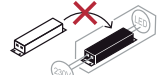

Valdymo įtaisas yra nekeičiamas.



Šviesos šaltinis yra nekeičiamas.

**NL:****Lichtbron:**

De lichtbron kan niet worden vervangen, omdat deze vanwege de constructie vast met het product eromheen verbonden is.

Dit product bevat een lichtbron van energie-efficiëntieklasse <E>.

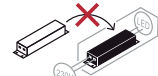

Apparaat kan niet worden vervangen.

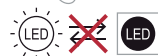

Verlichting kan niet worden vervangen.

**Norwegisch/Norwegian / NO:****Lyskilde:**

Lyskilden kan ikke byttes fordi den sitter fast i produktet.

Dette produktet inneholder en lyskilde i energiklasse <E>.

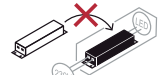

Driftsapparatet kan ikke byttes ut.



Lyskilden kan ikke byttes ut.

**PL:****Źródło światła:**

Źródła światła nie można wymienić, ponieważ jest zintegrowane z produktem ze względu na swoją konstrukcję.

Ten produkt zawiera źródło światła o klasie efektywności energetycznej <E>.

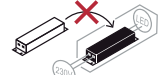

Osprzętu sterującego nie można wymienić.

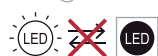

Źródła światła nie można wymienić.

**PT:****Fonte de Luz:**

A fonte de luz não é substituível porque devido às suas características construtivas está fixada de forma permanente ao produto circundante.

Este produto contém uma fonte de luz da classe de eficiência energética <E>.



Dispositivo de comando não substituível.

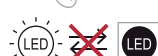

Lâmpada não substituível.

**RO:****Sursa de lumina:**

Sursa de lumina nu este inlocuibilă ea fiind parte constructivă a produsului  
Acest produs conține o sursă de lumină cu clasa de eficiență energetică <E>.

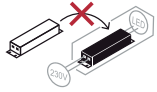

Unitatea de control nu poate fi schimbata



Sursa de lumina nu poate fi schimbata

**RUS:****Источник света:**

Источник света не является взаимозаменяемым, поскольку это определяется конструкцией смежного продукта.

Данный продукт содержит источник света класса энергоэффективности <E>.

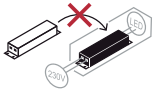

Незаменяемый регулировочный механизм



Незаменяемый источник света.

**SRB:****Izvor svetlosti:**

Izvor svetlosti nije zamenljiv, jer je zbog svog dizajna čvrsto povezan sa proizvodom koji ga opkružuje.  
Ovaj proizvod sadrži izvor svetlosti klase energetske efikasnosti <E>.

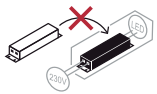

Upravljački uređaj nije zamenljiv.

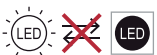

Izvor svetlosti se ne može zameniti.

**SK:****Zdroj svetla:**

Svetelný zdroj nie je možné vymeniť, pretože je vďaka svojej konštrukcii pevne spojený s produktom  
Tento výrobok obsahuje svetelný zdroj triedy energetickej účinnosti <E>.

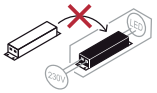

Predradník nie je vymeniteľný.



Svetelný zdroj nie je vymeniteľný.

**SI:****Izvor svetlobe:**

Vir svetlobe ni zamenljiv, ker je določen z zasnovo izdelka v okolici.  
Ta izdelek vsebuje svetlobni vir razreda energijske učinkovitosti <E>.

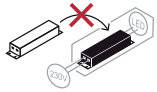

Nezamenljiv krmilnik.

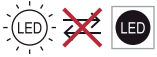

Nezamenljiv vir svetlobe.

**ES:****Fuente de luz:**

La fuente de luz no es sustituible porque está fija en el producto desde la construcción.  
Este producto contiene una fuente luminosa de la clase de eficiencia energética <E>.

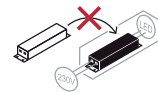

Dispositivo de control no reemplazable.

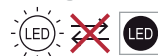

Bombilla no reemplazable.

**SE:****Ljuskälla:**

Ljuskällan är inte utbytbar, eftersom den på grund av konstruktionen är fast integrerad i den omgivande produkten.

Denna produkt innehåller en ljuskälla med energieffektivitetsklass <E>.



Driftdonet kan inte bytas ut.

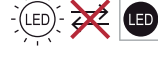

Ljuskällan är inte utbytbar.

**TR:****Işık kaynağı:**

Konstrüksiyon gereği çevreleyen ürün ile sabit bir şekilde bağlı olduğu için ışık kaynağı değiştirilemez.  
Bu ürün, <E> enerji sınıfından bir ışık kaynağına sahiptir.

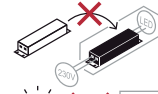

İşletme cihazı değiştirilemez.

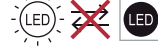

Aydınlatma malzemesi değiştirilemez.

**UK:****Джерело світла:**

Джерело світла не можна обміняти, оскільки воно міцно пов'язане з навколишнім виробом завдяки своїй конструкції.

Цей виріб містить джерело світла класу енергоефективності <E>.

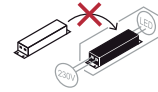

Редуктор не є змінним.

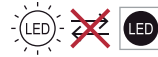

Цибулини не взаємозамінні.